



A 2pcs



B 1pcs



C 1pcs

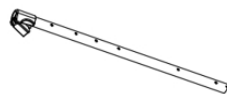

D 1pcs



E 1pcs

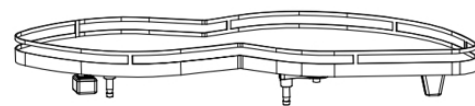

F 2pcs

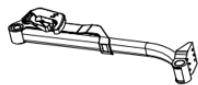

G 2pcs



H 2pcs



I 2pcs



J 2pcs



K 2pcs



M 13pcs



N 8pcs

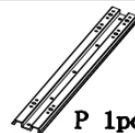

P 1pcs

1. Закрепите P, B и C как на рисунке (1)



Рисунок (1)

2. Установите G

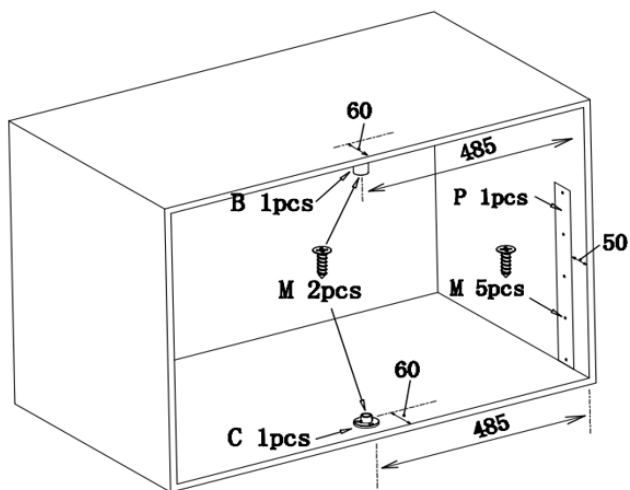

Рисунок (2)

3.

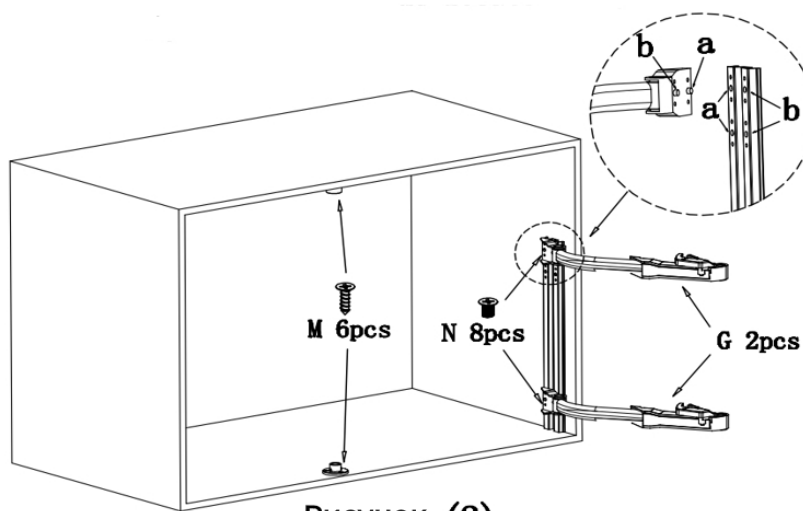

Рисунок (3)

4.

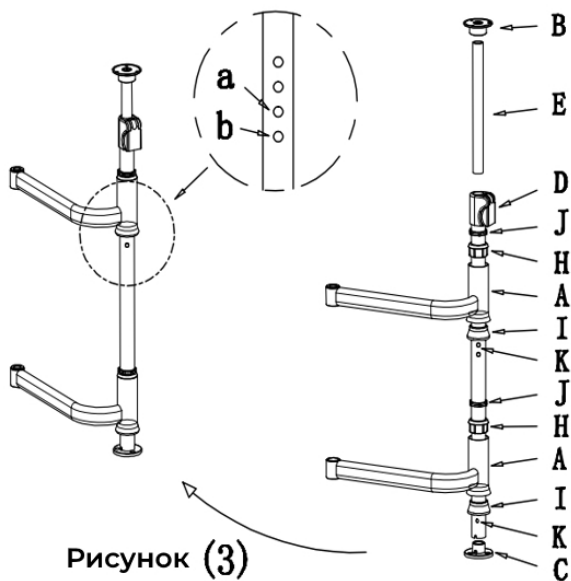
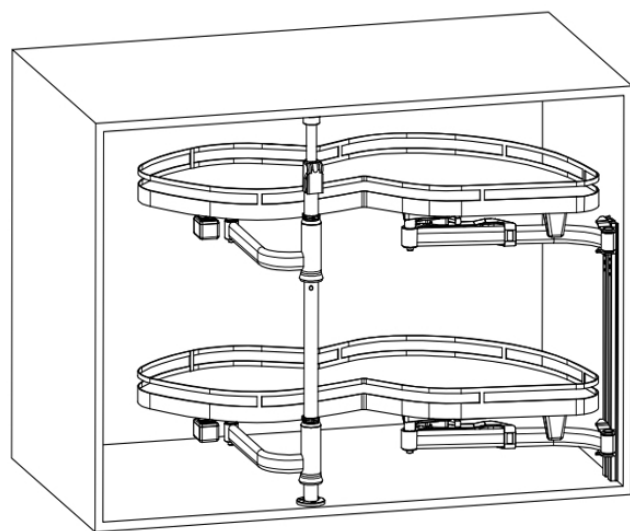

Рисунок (4)